



## **MATTHIEU LEMAY**

**Website:** [www.matthieulemay.com](http://www.matthieulemay.com)  
**Email:** [lemay.matthieu@gmail.com](mailto:lemay.matthieu@gmail.com)  
**Phone:** 1 (613) 315 3050  
**Address:** Kingston, ON, CAN

### **SUMMARY**

Highly motivated and project-oriented Biomedical Mechanical Engineering graduate, Architecture graduate, and entrepreneur with 4 years of professional work experience in design, research, and mechanical engineering fields. Designed and built several functional instruments including a patent pending medical device which lead to the co-founding of a startup company while still in university. Please visit [www.matthieulemay.com](http://www.matthieulemay.com) to view samples of project work.

### **EXPERIENCE**

#### **Co-founder and Product Developer**

Jan 2014 - Oct 2015

**Teple Inc** - Ottawa, ON, CAN

- Overcame technical and human factor challenges to translate the vision of a cardiac surgeon into a novel, patent pending electromechanical medical device (US14/743,128).
- Designed, built, programmed, and tested all mechanical and electrical systems of a functional prototype.
- Conducted market research, identified regulatory and reimbursement pathways, developed a commercialization strategy, and produced a preliminary business plan.
- Reached out to medical staff at various hospitals and conducted focus group sessions to obtain end-user feedback.
- Effectively communicated the device's purpose and functionality to advisors, business partners, patent agents, and grant agencies through the production of detailed reports, computer renderings, diagrams, and video animations.

#### **Mechanical Engineer CO-OP**

Sept - Dec 2014, May - Aug 2015

**StarFish Medical** - Victoria, BC, CAN

- Contributed significantly to the ideation, design, and early-stage development of several fast-paced and high-stakes projects including diagnostic, surgical, and drug delivery medical devices.
- Improved device performance by identifying and correcting failure modes and operational inconsistencies through FEA, mathematical analyses, and extensive operational and failure testing of mechanical assemblies.
- Commended by employer for consistently producing high quality work while meeting tight deadlines, and for playing a central role in the completion of an important project under budget.
- Used appropriate design methodologies along with manufacturing and rapid prototyping knowledge in the production of numerous functional prototypes.
- Kept clients informed with concise status update reports which presented experimental testing results and analyses.
- Consolidated mechanical, electrical, and biological systems in device designs by drawing from the diverse knowledge and experience of multidisciplinary teams.

#### **Research Assistant CO-OP**

May - Aug 2013

**Orthopaedic Bioengineering Laboratory** - Ottawa, ON, CAN

- Improved the results, repeatability, and execution of a key experiment by volunteering to design and manufacture a custom automated syringe pump platform used for polymer microsphere extrusion.
- Learnt entirely new sets of laboratory skills used to perform the analysis of peripheral blood lymphocyte phenotypes from patients with failed hip implants by cell staining and flow cytometry.
- Commended by employer for excellent technical writing skills in the production of standard operating procedure documents.



## MATTHIEU LEMAY

Website: [www.matthieulemay.com](http://www.matthieulemay.com)  
Email: [lemay.matthieu@gmail.com](mailto:lemay.matthieu@gmail.com)  
Phone: 1 (613) 315 3050  
Address: Kingston, ON, CAN

### EXPERIENCE Cont'd

#### **Product Developer and Manager (volunteer)**

May 2013 - April 2015

**UO Skills and Simulation Centre** - Ottawa, ON, CAN

- Reached out to medical community to identify a real need for a medical device.
- Volunteered to develop a remotely controlled artificial blood pumping system for use in surgical training simulations.
- Identified technical requirements and usability considerations by consulting with a team of surgeons and engineers.
- Designed, sourced components, and built a first functional prototype.
- Assembled and lead a small team in the completion of a second prototype.

#### **Architectural CO-OP**

**Shoalts and Zaback Architects Ltd** - Kingston, ON, CAN

2006,'07,'09,'11,'12

**Busby Perkins + Will Architects** - Vancouver, BC, CAN

2010

**3XN Architects** - Copenhagen, DK

2008

**Zeidler Partnership Architects** - Victoria, BC, CAN

2008

- Selected to work in a small team on an award-winning, sustainable building project (VanDusen Garden Visitor Centre, Vancouver, BC).
- Organized and lead several meetings with clients, consultants, and co-workers.
- Contributed to the design process of several large scale building projects.
- Worked on complex construction details for tender and construction documents.
- Coordinated teams in the production of architectural content for a marketing website, and in the construction of a complex architectural model.

### EDUCATION

#### **BASc Biomedical Mechanical Engineering (CO-OP)**

2011 - Dec 2015

**University of Ottawa** - Ottawa, ON, CAN

- 8.8/10 CGPA, Dean's Honour List.
- Award for Best Innovation and Creativity, and Award for Best Overall Presentation at Professional Engineers Ontario Student Paper Night 2014 and 2015, respectively.
- Nominated for the uOttawa CO-OP Student of the Year Award 2013 and 2015.

#### **Honours Bachelor of Architectural Studies (CO-OP)**

2006 - 2011

**University of Waterloo** - Cambridge, ON, CAN

- Graduated with distinction, above 80% cumulative average.
- Awarded Teacher Assistantship in a computer visualization course.
- Twice elected UW Architecture Student Association Computing Representative.
- Awarded University of Waterloo President's Scholarship.

### RELEVANT SKILLS

- Fluent in English and French, oral and written.
- Reliable, and driven to produce high quality work while meeting deadlines.
- Excellent problem solving skills, attention to detail, and design methodology.
- Proficient in SolidWorks, AutoCAD, SketchUp, V-Ray, KeyShot, Microsoft Office Suite, and Adobe Creative Suite.
- Experienced in C programming language, Arduino microcontrollers, and electronic prototyping.
- Ability to effectively apply concepts from mechanics, biomechanics, thermodynamics, vibrations, control systems, mathematics, materials, electrical circuits, chemistry, and biology.

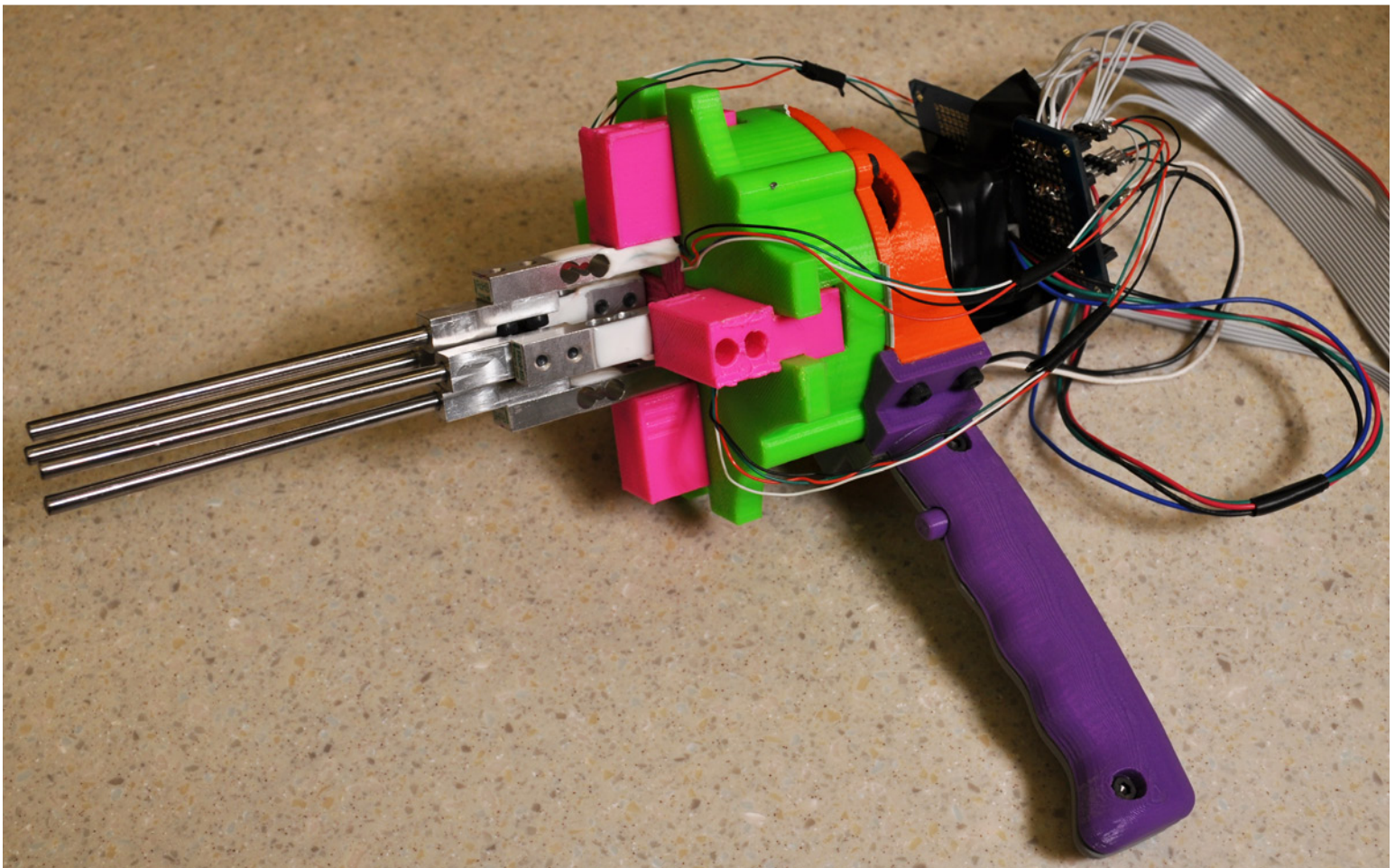
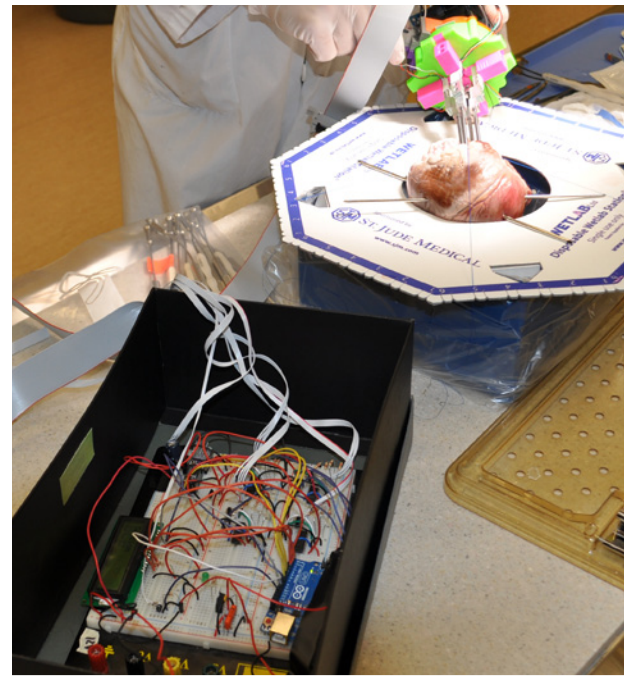
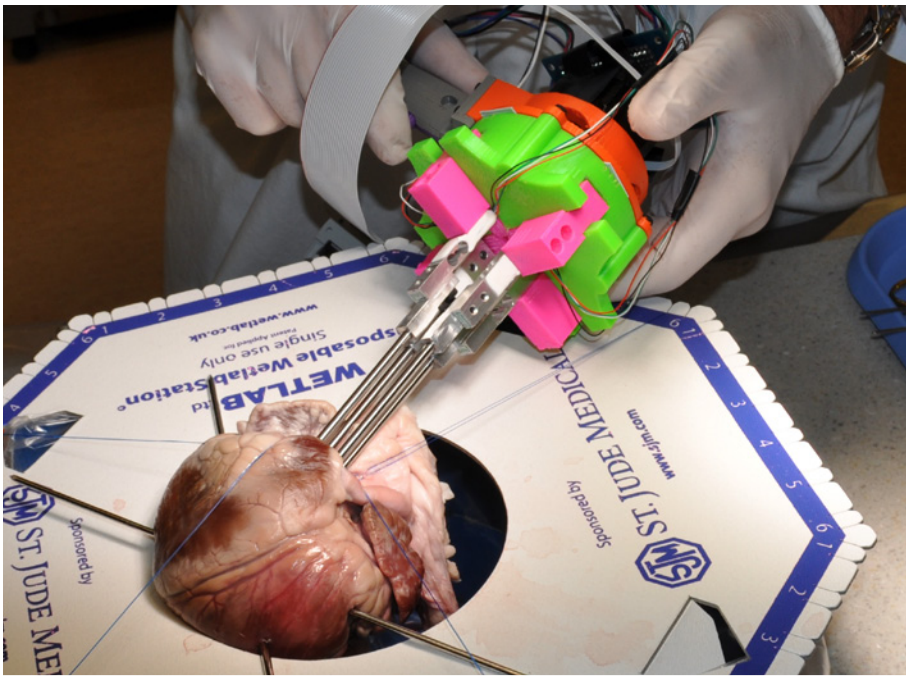

## SULUNA, HEART VALVE SIZER

The Suluna device was designed to assist surgeons in selecting the appropriate size of artificial heart valve to be implanted. Given that every patient's heart anatomy is unique, correctly sizing and fitting the artificial valve to the patient is crucial to the procedure's long-term success. The Suluna device replaces the large sizing kits currently being used and allows the surgeon to quickly perform the sizing during the surgery using a single instrument.

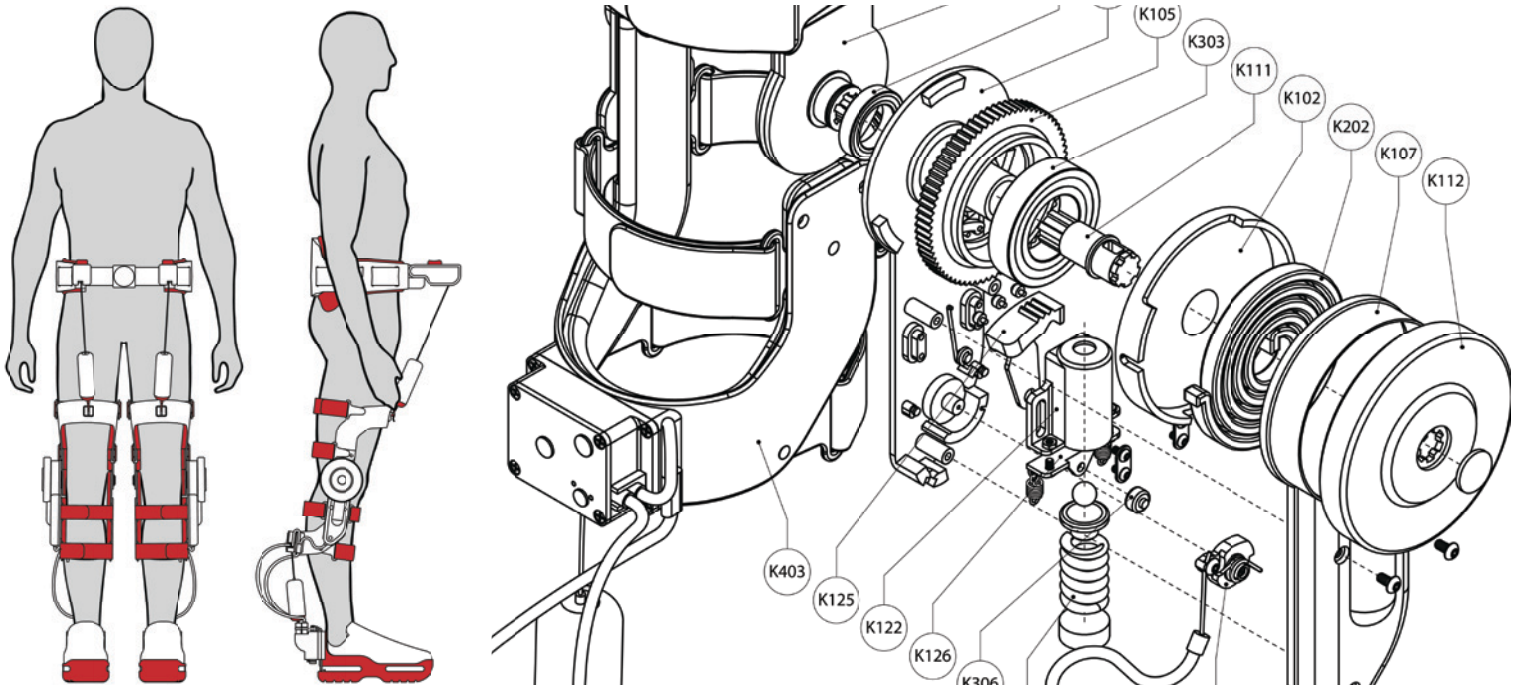

**STRYDER, PASSIVE EXOSKELETON**

The STRYDER is a passive assistive exoskeleton designed to increase the efficiency of walking, thereby extending the user's walking range. The STRYDER's design was inspired by three conceptual pillars: harvesting and releasing the potential energy of the user's centre of mass, precluding any restriction to natural joint motion so as to avoid compromising natural stability, and utilizing reliable event-based actuation triggers.

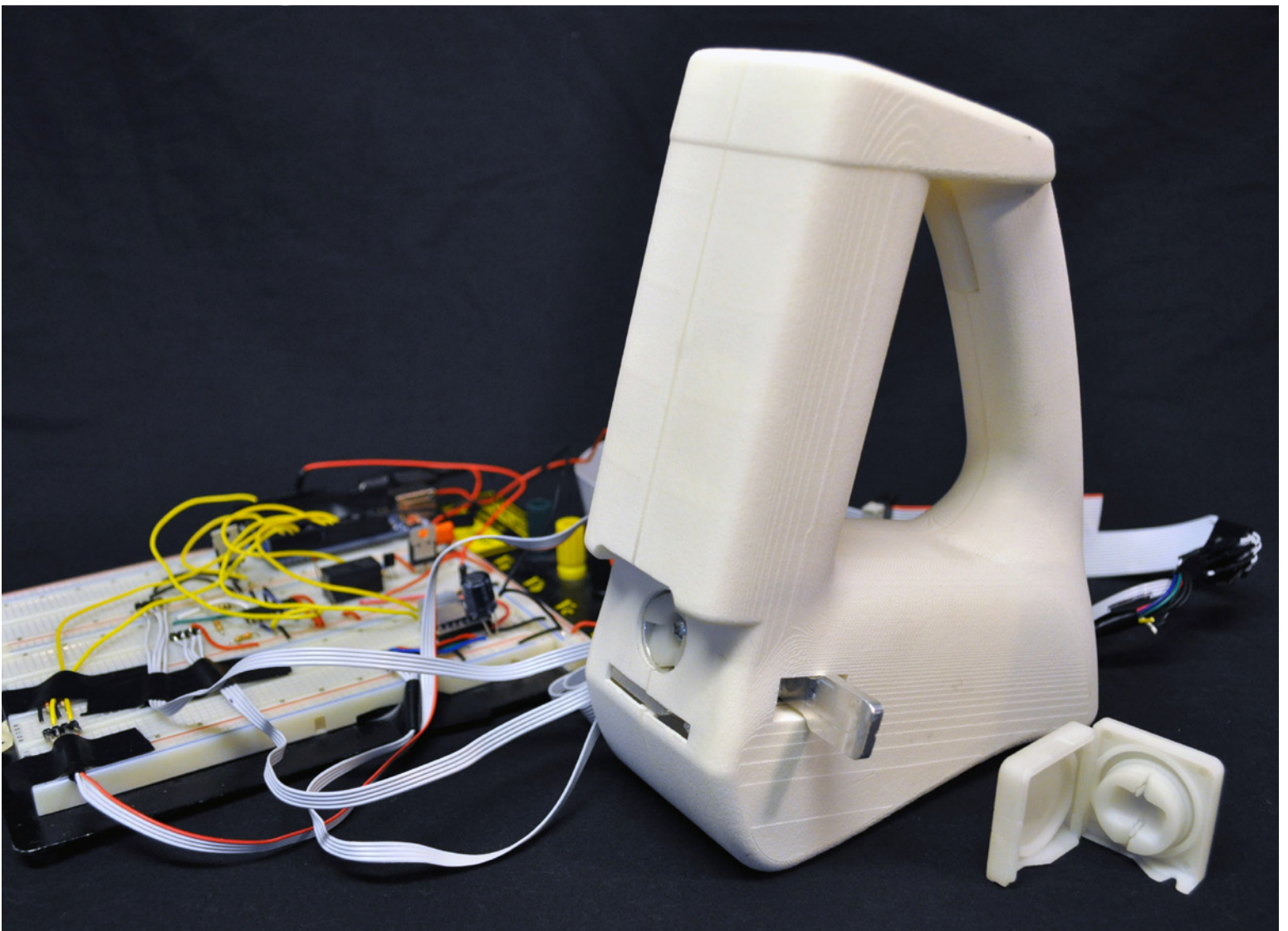
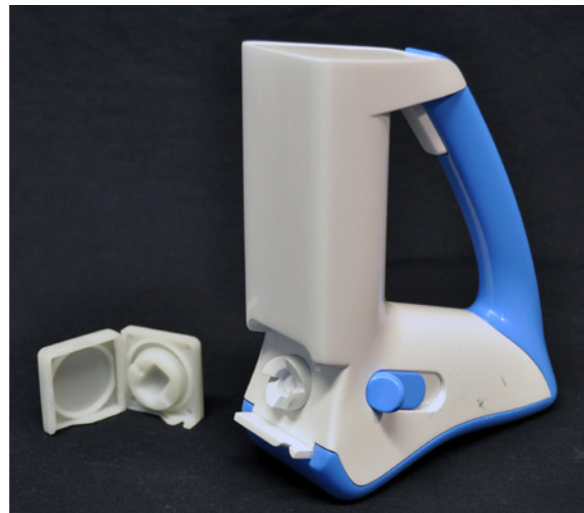
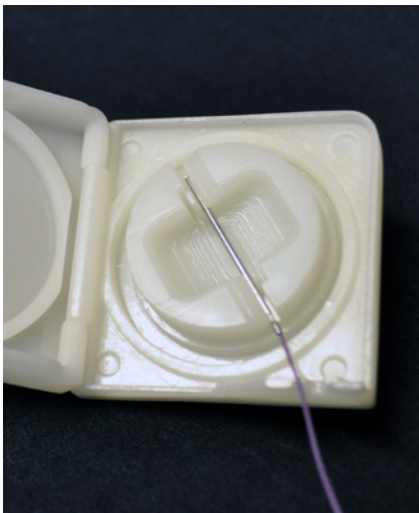

## **TEPLE (patent pending)**

The TEPLE (Temporary Epicardial Pacing Lead Extractor) is the result of an exciting collaboration with Dr. Fraser Rubens, cardiac surgeon at the Ottawa Heart Institute. The aim of the project was to develop a device that automates the extraction of temporary epicardial wires in order to eliminate the subjectivity inherent to the procedure, thereby reducing risk to the patient.

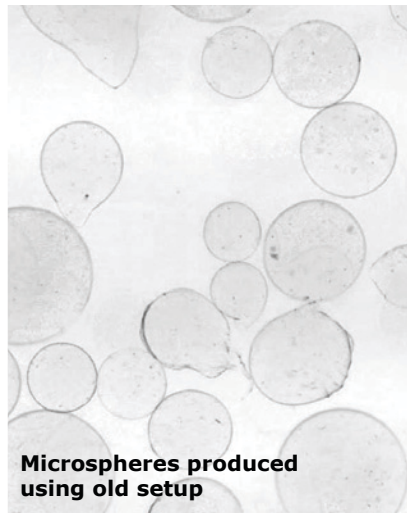
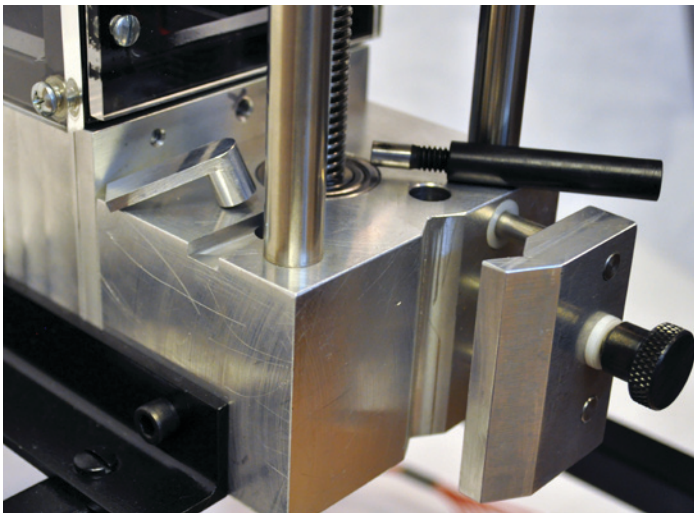

Microspheres produced using old setup



Microspheres produced using the new PME device

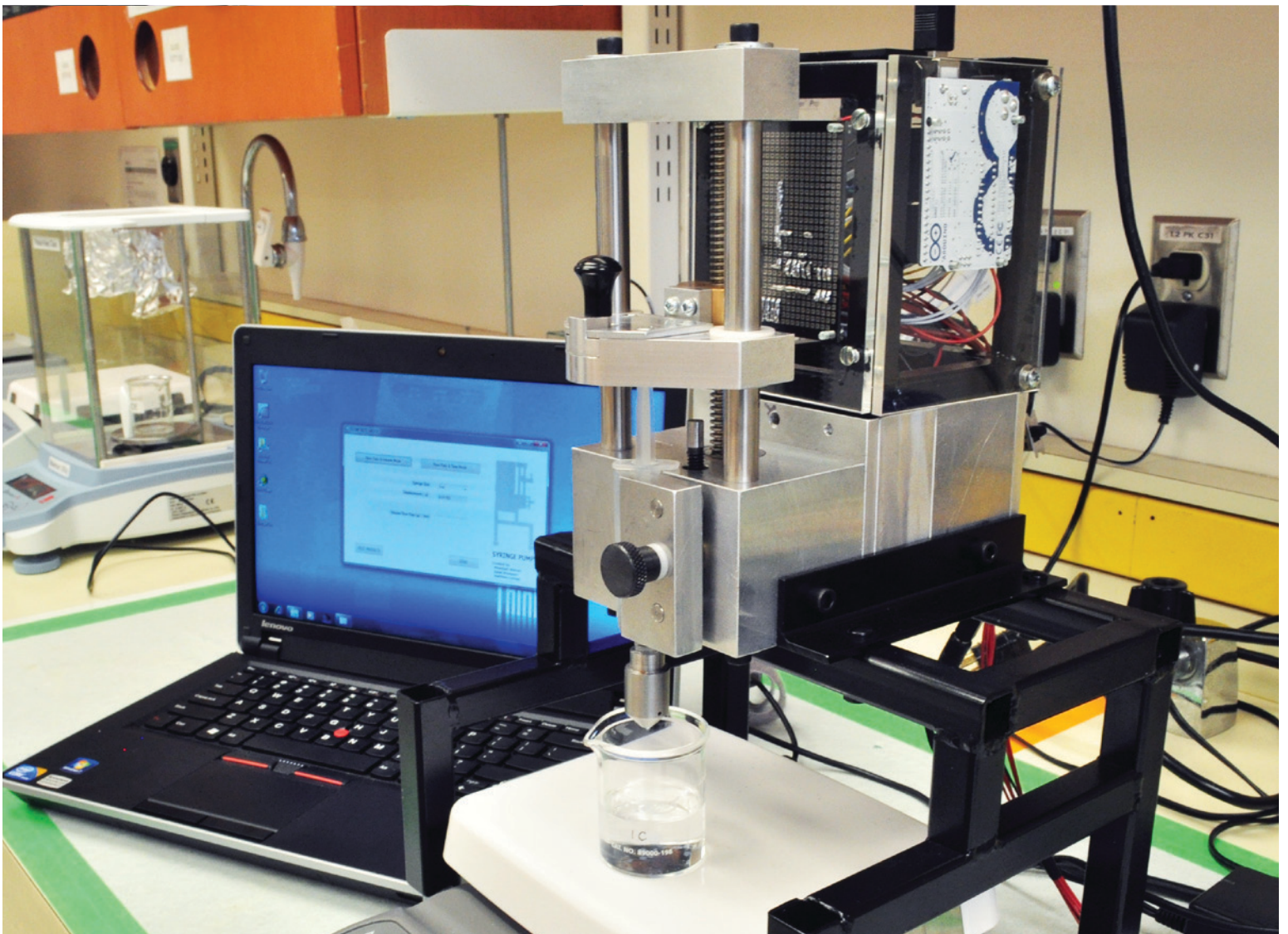

## POLYMERIC MICROSPHERE EXTRUDER

The Polymeric Microsphere Extruder (PME) is a custom-made syringe pump platform being used, as of January 2014, to produce drug-infused microspheres for research conducted at Dr. Isabelle Catelas' Orthopaedic Bioengineering Laboratory at the University of Ottawa. The PME was designed to replace the unreliable setup being used at the time, and integrates all the elements required for the extrusion process into one cohesive, easy-to-use, and reliable system.